



ScichemTech-USA

SCT-108.005.09

SCT-TDS-MINI

**ScichemTech TDS Mini Controller
User/Operational Manual**



MANUAL INDEX PAGE

Serial Number	Description	Page Number
I	Model and Instrument Type	03
II	Principle & Operations	03
III	Technical Specifications	06
IV	Un-packing & pre-installation requirements	07
V	Installation & Method of operation	07
VI	Calibration of the controller	10
VII	Pre-cautions & Maintenance	11
VIII	Warranty and return policies	13

I. MODEL AND INSTRUMENT TYPE

Thank you for purchasing and selecting Our SCT- Product Number: SCT-108.005.09
Model: SCT-TDS-MINI – The online TDS Controller.

Once again we thank you for choosing our Model: SCT-TDS-MINI – The online TDS Controller for your TDS related field applications. We are pretty sure that you will be happy with our Instruments...Please feel free to contact our dealers /service team for any further assistance.

II: PRINCIPLE & OPERATIONS:

The term "total solids" refers to matter suspended or dissolved in water or wastewater, and is related to both specific conductance and turbidity. Total solids (also referred to as total residue) is the term used for material left in a container after evaporation and drying of a water sample. Total Solids includes both total suspended solids, the portion of total solids retained by a filter (usually with a pore size of 0.45 micrometers), and total dissolved solids, the portion that passes through a filter (American Public Health Association, 1998). Total Dissolved Solids (TDS) are solids in water that can pass through a filter. TDS is a measure of the amount of material dissolved in water. This material can include carbonate, bicarbonate, chloride, sulfate, phosphate, nitrate, calcium, magnesium, sodium, organic ions, and other ions. A certain level of these ions in water is necessary for aquatic life. Changes in TDS concentrations can be harmful

because the density of the water determines the flow of water into and out of an organism's cells . However, if TDS concentrations are too high or too low, the growth of many aquatic life can be limited, and death may occur.



TDS is used to estimate the quality of drinking water, because it represents the amount of ions in the water. Water with high TDS often has a bad taste and/or high water hardness, and could result in a laxative effect.

Total dissolved solids are differentiated from total suspended solids (TSS), in that the latter cannot pass through a sieve of two microcontrollers and yet are indefinitely suspended in solution. The term "settleable solids" refers to material of any size that will not remain suspended or dissolved in a holding tank not subject to motion, and excludes both TDS and TSS. Settleable solids may include larger particulate matter or insoluble molecules.

TDS controllers are, in reality, conductivity controllers. They work by applying a voltage between two or more electrodes. Positively charged ions (e.g., sodium, Na^+ ; calcium, Ca^{++} ; magnesium, Mg^{++} ; hydrogen ion, H^+ ; etc.) will move toward the negatively charged electrode, and negatively charged ions (e.g., chloride, Cl^- ; sulfate, SO_4^{--} ; bicarbonate, HCO_3^- ; etc.) will move toward the

IONIC PRINCIPLE

=====

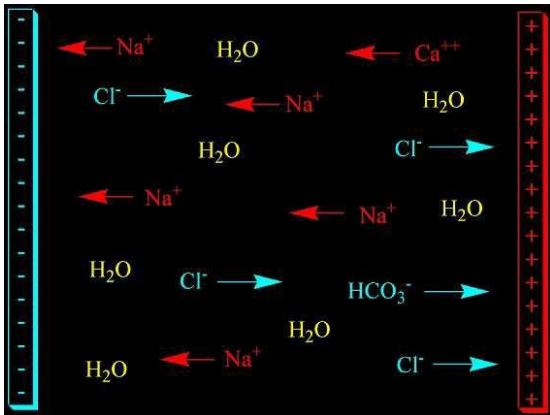

Schematic diagram of a conductivity electrode, showing negatively-charged anions (blue) moving toward the positively charged electrode, positively-charged cations (red) moving toward the

Positively charged electrode in the above **Schematic diagram**. Because these ions are charged and moving, they constitute an electrical current. The controller then monitors how much current is passing between the electrodes as a gauge of how many ions are in solution. Since TDS controllers are often used to test water "purity," it is important to understand what they do not detect. As conductivity controllers in disguise, TDS controllers will only detect mobile charged ions. They will not detect any neutral (uncharged) compounds. Such compounds include sugar, alcohol, many organics (including many pesticides and their residues), and unionized forms of silica, ammonia, and carbon dioxide. These controllers also do not detect macroscopic particulates, as those are too large to move in the electric fields applied. So if you see "rusty" looking water from iron oxide particulates, that won't be measured. Neither will anything else that makes the water look cloudy. Bacteria and viruses also won't be detected.

Consequently, the term "total dissolved solids" is really quite a misnomer. "Total charged ions" is likely a much better term for what it measures.

III: About the Product & Applications:

Our SCT- Product Number: 108.005.09

*Model: **SCT-MINI TDS Controller.***

Is a very reliable, accurate and consistent instrument you can always rely upon the Controller for all you Water PH control related applications within it's measuring range.

SALIENT FEATURES:

- SCT -TDS (Total Dissolved Solids) MINI CONTROLLERS are designed with creativeness to get the elegance and produced with proper quality , and meets the specifications for the Water related applications with high level performance .

- SCT -TDS (Total Dissolved Solids) MINI CONTROLLERS are supplied with the suitable electrode with SCT standard 10 meters cable.(new series).
- SCT -TDS (Total Dissolved Solids) MINI CONTROLLERS are an industrial instrument used for online analysis and monitoring.
- SCT -TDS (Total Dissolved Solids) MINI CONTROLLERS are made in a attractive pleasant colour with a Large and Clear blue white LCD Display
- SCT -TDS (Total Dissolved Solids) MINI CONTROLLERS are Microprocessor based controllers, which gives stable and accurate readings.
- SCT -TDS (Total Dissolved Solids) MINI CONTROLLERS uses Low power consumption and produces less internal heat.
- SCT -TDS (Total Dissolved Solids) MINI CONTROLLERS has an isolated 4-20 mA current output.
- SCT -TDS (Total Dissolved Solids) MINI CONTROLLERS proved to work continuously in any harsh environmental conditions for the In line measurement and control of accurate TDS value and it give the direct measurement and readings .

Applications of SCT-TDS MINI Controller.

SCT-MINI TDS Controllers are designed for the measurement and control of industrial on-line TDS, widely used in the RO (Reverse Osmosis) Panels for the measurement and control of the water. In the Water purification plants, Production plants of pure water in pharmaceutical industries, chemical industry, electronic industry, foodstuffs, beverage and etc.

However, SCT-108.005.09 can be used in many other fields & applications too.

III. TECHNICAL SPECIFICATIONS

Of Our SCT- Product Number: SCT-108.005.09

Model: SCT-TDS-MINI – The online TDS Controller

Measuring range:	0~19.99, 0~199.9, 0~1999 ppm (three-grade range, keyboard selection)
Display method:	liquid-crystal display with 3½ bit LCD Segment code
Accuracy:	1.5% (FS)
Stability:	±2×10 ⁻³ (FS)/24h
Work pressure:	0~0.5MPa
Media temperature:	0~50°C
Temperature compensation:	with 25°C as the reference point, digital compensation
Output current:	isolation of 4~20mA active output
Control output:	High limit relay, low relay (normally open)
Contact capacity:	8A/240V AC (with resistance load)
Optional electrode:	1.0cm-1 metal electrode
Cable length:	5m in normal condition or ___m otherwise provided
Environment condition:	temperature: 0~50°C; humidity: ≤85%RH
Power supply:	AC 220V±10% 50Hz

Overall dimension:	83×53×93mm (height x width x depth)
Face opening:	74×43mm
Installation method:	panel-mounted

IV: UN-PACKING & PRE-INSTALLATION REQUIREMENTS:

Follow these steps after receiving the instrument:

- Please check carefully the packaging box of the Controller before removing it in order to find out transportation damages.
- Should the packaging box be broken or have suffered any other damage, please contact the shipping agency before opening it.
- Once you have taken the instrument out of the box, check if damages can be observed. Should this be the case, please inform the dealer that has delivered you the equipment.
- Remove all packing straps, protectors and accessories used during transport. Recyclable materials are to be disposed in the containers provided therefore.
- Make sure to pre-warm or run the controller for 30-35 minutes prior to using and performing the calibration work
- Also, please make sure all the Electrical connections and the probes are connected properly.
- The meter should be installed in a clean, dry, well ventilated, vibration-free location around should be no corrosive gases.
-

V. INSTALLATION & METHOD OF OPERATIONS

5.1. Main installation

- As we mentioned earlier, the meter should be installed in a clean, dry, well ventilated, vibration-free location around should be no corrosive gases. Make a rectangular cut out in the instrument cabinet or panel installation. Using the locking tools fix the Controller firmly into the Panel or Cabinet.

5.2. Electrode installation

- TDS electrode loaded in to the flow cell is shown in Fig. Such as the use of sinking into the (insertion) type installation, an electrode without the flow measuring chamber, directly, respectively, TDS electrode is connected to the connecting rod (water) to prevent the electrode cable can be fixed after inserted into the water, with the fixing bracket. Before installation, be sure to use the raw material with the (threaded Department) good waterproof closed. The measured media should be kept online monitoring and constant minimum flow rate of 15cm³/S.

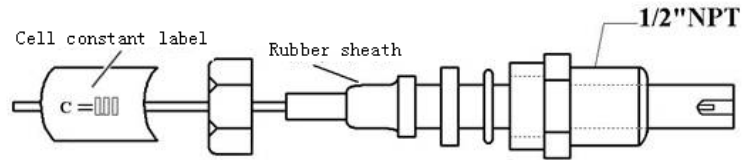

The measuring electrode is a kind of compound electrode with plastic housing with 3/4" NPT pipe thread joint.

5.3. INSTALLATION OF THE TDS CONTROLLER

5.1 Back cover plate

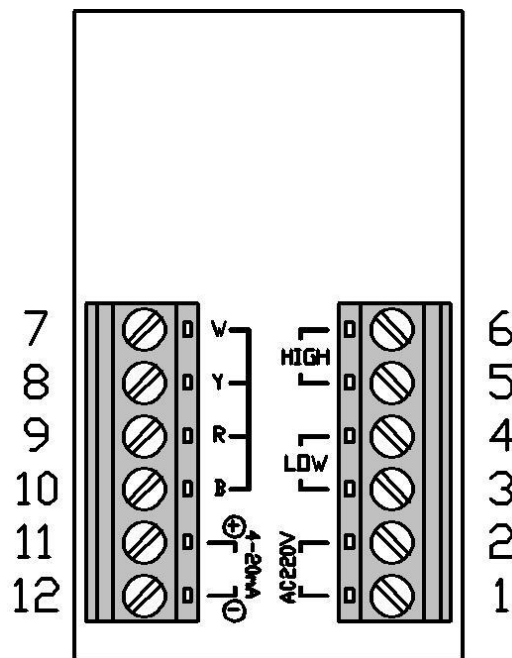

The back cover plate

Description:

1. Alternating current 200V (L)
2. Alternating current 200V (N)
3. Normally open terminal of the low limit control relay
4. Normally open terminal of the low limit control relay
5. Normally open terminal of the high limit control relay

6. Normally open terminal of the high limit control relay
7. White thread end of the measuring electrode
8. Yellow thread end of the measuring electrode
9. Red thread end of the measuring electrode
10. Black thread end of the measuring electrode
11. Positive output of 4-20 mA
12. Negative output of 4-20 mA

5.4. CONTROLLER OPERATION

5.4.1 Keyboard

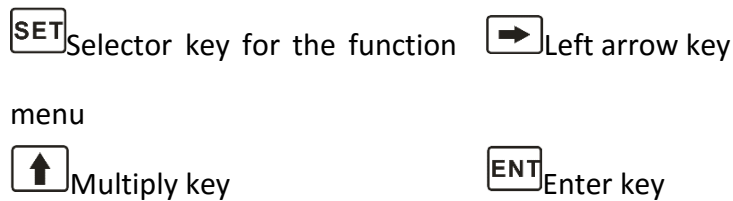

5.4.2 Instrument operation

5.4.2.1 TDS operation menu:

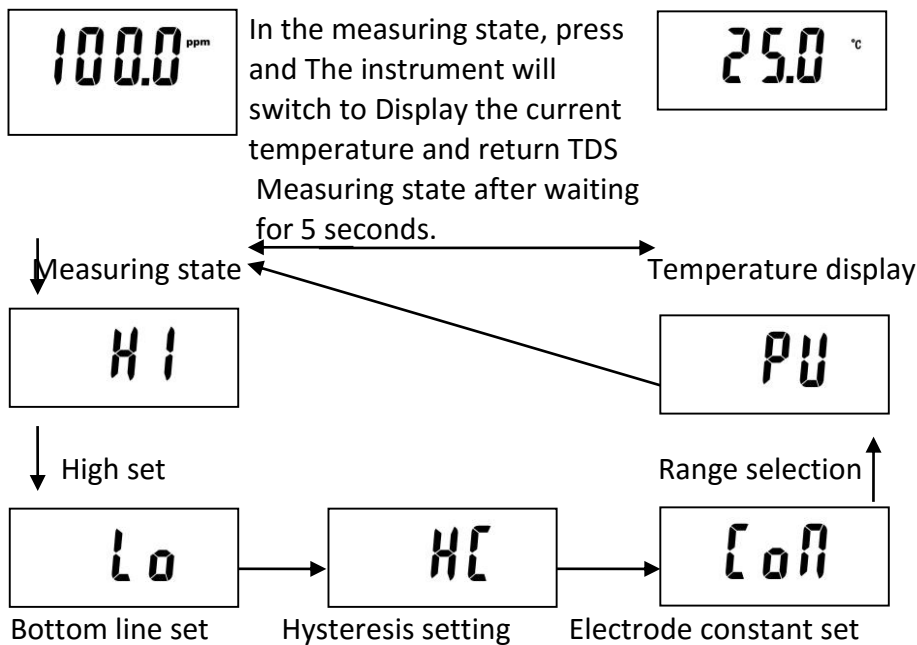

Instructions: Keep pressing the **SET** key, and the “Set” options of the instrument will shift among the above statuses. Press the **ENT** key, and the instrument will enter into the set menu. Press the **➤** and **▲** keys to modify the value to be set. Finally, press the **ENT** key to save the set data.

Note: 1. after the setting of an option, it is necessary to press the **↻** key to save the required data. Then the set values will stop flickering!
2. The high or low limit can be set within the whole range. However, the high limit must be greater than the low limit.

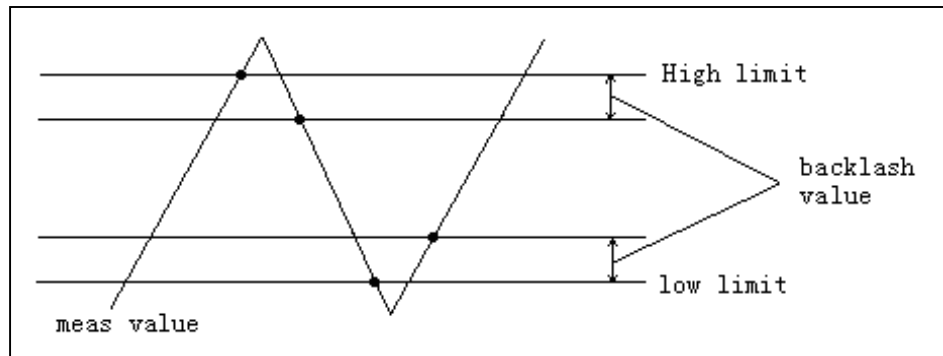

The hysteresis range of the upper and lower limits

VI. CALIBRATION OF THE TDS CONTROLLER

Calibration is to ensure accurate measurements from your TDS Controller. The controller will need to be calibrated both before its first use and on an ongoing basis. This is usually done by dipping the probe into a buffer solution of a known TDS and following the calibration steps based on our specific TDS Controller.

One-point calibration should be adopted. During the calibration process the controller will be calibrated to the known buffer.

Before calibration, prepare the buffer solution with tds values of 1382 ppm respectively according to the requirements. Before calibration, the electrode should be dipped into clean water or the test solution for 5 minutes.

The calibration method is as follows: (under the measuring status)

- (1) Press the **SET** key until the instrument displays “CON”, which indicates that the instrument enters into the electrode constant mode.
- (2) Press the **ENT** key, and the instrument will display the already entered electrode constant. Then insert the cleaned electrode into the know TDS buffer solution.
- (3) Press the “SET” key until the measuring mode is seen.
- (4) Check whether the displayed value is more or less than the known buffer solution,
- (5) If the measured value is lesser than the known buffer solution press the **SET** key until the

instrument displays "CON".

(6) Change the electrode constant value greater than the entered value. Again check the displayed value in measuring mode.

(7) Likewise adjust the electrode constant until the measuring mode displays the correct buffer value.

(8) Follow the same procedure if the displayed value shows more than the known buffer solution but instead of increasing the electrode constant decrease the value until the measuring reading is equal to the known buffer solution.

VII: PRECAUTIONS & MAINTANANCE:

Maintenance:

- 1) The electrode cannot be stored in dry environment. When it is not in use, it is necessary to wash it with clean water.
- 2) The electrode should be cleaned on a regular basis.

1. Surfactant can be used to clean oil, grease or oil-containing substance.

2. 10% diluted hydrochloric acid can be used to remove calcium deposit or metal hydroxides.

3. 10% diluted hydrochloric acid can be used to remove sulTDSide precipitation. Protein attachment can be removed by a mixture of 10% diluted hydrochloric acid and pepsin.

In order to ensure that the results of the electrode measurement can reflect the actual situation, the electrode chamber should have no air bubble or stagnant water that may cause measurement errors. Install the measuring electrode according to the diagram.

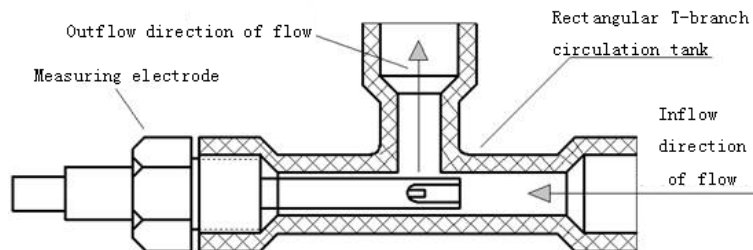

Note:

1. The measuring electrode should be installed at a location in the pipeline where the flow rate is stable and air bubbles will not gather easily.

2. The measuring electrode should go deep into the flowing water. The tds signal is a kind of feeble potential signal. The cables for collecting tds signals should be installed independently instead of being laid in the same protection tube with the power cable and the control cable, so as to prevent any possible disturbance.

7. TDS ELECTRODE / PROBE MAINTENANCE

A system's TDS electrodes require periodic maintenance to clean and calibrate them. The length of time between cleaning and calibration depends on process conditions and the user's accuracy and stability expectations. Overtime, electrical properties of the measuring and reference electrode change. Calibration in known-value TDS solutions called buffers will correct for some of these changes. Cleaning of the measuring sensor and reference junction will also help. However, just as batteries have a limited life, a TDS electrode's lifetime is also finite. Even in the "friendliest" environments, TDS electrodes have to be replaced eventually.

1. As the measuring electrode is a kind of precision component, do not get it out from the measuring chamber frequently unless under necessary conditions. Wash TDS electrode on a regular basis.
2. Only special-purpose cables can be used for the measurement and no other type of cable can be used for this purpose. Using unqualified cables for measuring purpose will result in large error.
3. If the measuring electrode is damaged or disabled, it is necessary to replace it with the same type of combined electrode. Then calibrate the newly replaced measuring electrode according to Chapter 5 of this instruction manual.
4. This instrument is an assembly of precision integrated circuit and electronic organs. Therefore, precautions should be taken to protect the instrument from any possible damage by humidity.

Optional Spares / Accessories can be ordered separately.

SCT-108.005.09A	TDS probe with 10 meter cable
SCT-108.002.BA	84 uS/cm conductivity standard solution 500ml
SCT-108.002.BD	1413 uS/cm conductivity standard solution 500ml
SCT-108.005.09B	Mounting clamps

As a quality control procedure ,before releasing the controller for sale. Our Quality control in the factory performed & assures the following conformity as per the standards.

CONFORMITY DECLARATION	
Application of Council Directive	
Standards to Which Conformity is Declared:	
Compliance Testing	<ul style="list-style-type: none"> • Vibration to EN 60945 - Section 8.7 • Dry Heat to EN 60945 – Section 8.2 • Damp Heat to Lloyds register Test Spec. No. 1 Section 14 • Low Temperature to EN 60945 – Section 8.4.2 • 22 Degree Tilt operation
Emissions & Immunity	Tested and passed: EN61326-1: 2006
Product Safety	Tested and passed: ETL (tested to ANSI/ UL61010-1-2004)

	Tested and passed ETL (tested to CAN/CSA C22.2 No.61010.1-2 nd Edition, dated July 12, 2004)
I, the undersigned, hereby declare that the equipment specified above conforms to the above Directive and Standard Dr.C.R.Nath, in the Capacity of : Managing Director of ScichemTech-USA 2 nd Nov 2013	

VIII. SCT-INTERNATIONAL WARRANTY & RETURN POLICIES

This SCT-TDS-MINI has been subject to thorough testing and quality control. In the unlikely event of any manufacturing faults occurring, our one year warranty (from the date of delivery) covers SCT-TDS-MINI This warranty becomes void in case of incorrect operation, use of non-appropriate spare parts or accessories and non-authorized modification of the SCT-TDS-MINI. The warranty for the probes are generally for 6 months, based on the customer's use. Should you have any questions about SCT-TDS-MINI or require service, please contact the ScichemTech-USA through E-mail: service@scichemtech.com or ScichemTech's local service Dealer in your Country. Please have the unit's serial number (located on the back panel of the instrument) available when making the complaint. Do not send the unit for service without getting the repair authorization number. Should the SCT-TDS-MINI need service be sure to decontaminate it. The unit should be properly packed to avoid damage. Any damage resulting from improper packing shall be the responsibility of the user or the buyer.



CAUTION! SCT-TDS-MINI SHOULD BE OPERATED BY THE TECHNICAL STAFF AND MAINTAINED BY PROFESSIONAL ENGINEER.



Scientific Chemical Technologies LLC (ScichemTech®)

952-Troy Schenectady Road, Executive Office Suite 110,
Latham, NY 12110, ALBANY County, United States Of America.
Tel: 001 - 518 - 925 - 4470 Fax: 001 - 316 - 223 - 1805
E-mail: sales@scichemtech.com Web : www.scichemtech.com

An ISO 9001:2008 Certified Firm & An Active Member of Colonie Chamber of Commerce